



Organic Light Emitting Diode

Bogi Kavya and T. Kavitha

EasyChair preprints are intended for rapid dissemination of research results and are integrated with the rest of EasyChair.

July 25, 2020

CHAPTER-1

INTRODUCTION TO OLED'S

Organic opt-electronic devices including organic resonant tunneling diodes, OLEDs, organic phototransistors, organic photovoltaic cells, and organic photodetectors have formed a tremendous area of research in chemistry and physics. Electroluminescent devices based on organic materials are of considerable interest owing to their attractive characteristics and potential applications to flat panel displays. An OLED is a device which emits light under application of an external voltage. There are two main classes of OLED devices: those made with small organic molecules and those made with organic polymers. OLEDs have the unique properties of lightweight, flexible, transparent and color tune ability, which makes them an ideal modern light source. Interest in OLEDs is explained by the manifold benefits presented by this technology: operation in emissive mode (not require backlighting), a wide viewing angle, a low operating voltage (less than 5V), light emission throughout the visible (by modifying the chemical structure of material), flexible displays and reduced production costs. OLED displays are based on component devices containing organic electroluminescent material (made by small molecules or polymers) that emits light when stimulated by electricity. An OLED is a solid-state semiconductor device that is 100 to 500 nanometers thick and consists of a conducting layer and an emissive layer, all together sandwiched between two electrodes and deposited on a substrate. The conducting layer is made of organic plastic molecules that transport "holes" from the anode. The emissive layer is a film of organic compound that transport electrons from the cathode and emits light in response to an electric current. The conduction in organic layer is driven by delocalization of π electrons caused by conjugation over all or part of the organic molecule. Hence, the conducting levels in organic molecules can be varied from that of an insulator to a conductor. The interface between the two layers provides an efficient site for the recombination of the injected hole–electron pair and resultant electroluminescence. Thus, OLEDs are double charge injection devices, requiring the simultaneous supply of both electrons and holes to the electroluminescent material sandwiched between two electrodes (Figure 1). In the two layers based OLED; at the electrode-organic layer interface, electrons are injected from the cathode in the conduction band (LUMO) of the organic compound, and holes are injected from the anode in the valence band (HOMO) of the organic compound.

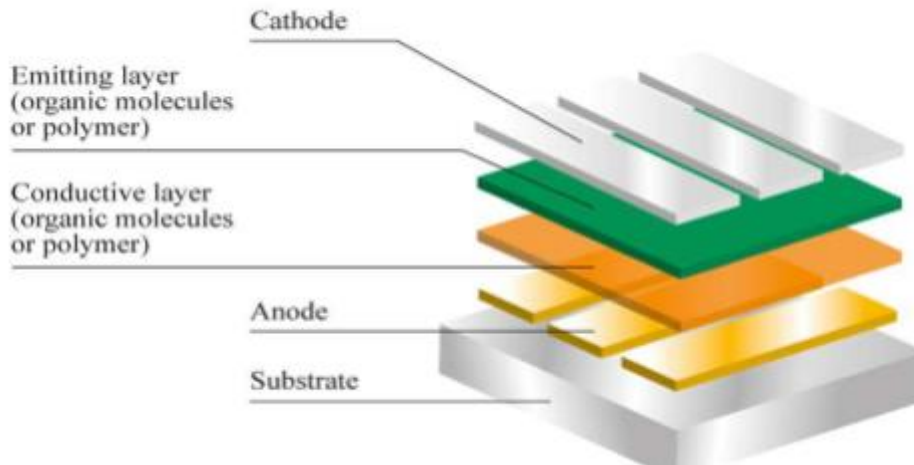

Figure 1: Fundamental Structure of OLED

In the three layers based OLED; the conductive layer is replaced by two more effective layers: electrontransport layer (ETL) and hole-transport layer (HTL). When the anode is at a more positive electrical potential with respect to the cathode, injection of holes occurs from the anode into the HOMO of HTL, while electrons are injected from the cathode into the LUMO of ETL. Under the influence of an applied electric field, the injected holes and electrons each migrate toward the oppositely charged electrode following a hopping transport regime which consists in a series of “jumps” of the charge from molecule to molecule. In the organic emissive layer (EML), when an electron and hole localize on the same molecule and are spatially close, a fraction of them recombine to form an exciton (a bound state of the electron and hole); which is a localized electron-hole pair having an excited energy state. Then some of these excitons relaxes via a photoemissive mechanism and decay radiatively to the ground state by spontaneous emission. In some cases, the exciton may be localized on an excimer (excited dimer) or an exciplex (excited complex). Non-radiative mechanisms, such as thermal relaxation, may also occur, but are generally considered undesirable. Upon recombination, energy is released as light and at least one electrode must be semi-transparent to enable a light emission perpendicular to the substrate. The result is a very bright and crispy display with power consumption lesser than the usual LCD and LED

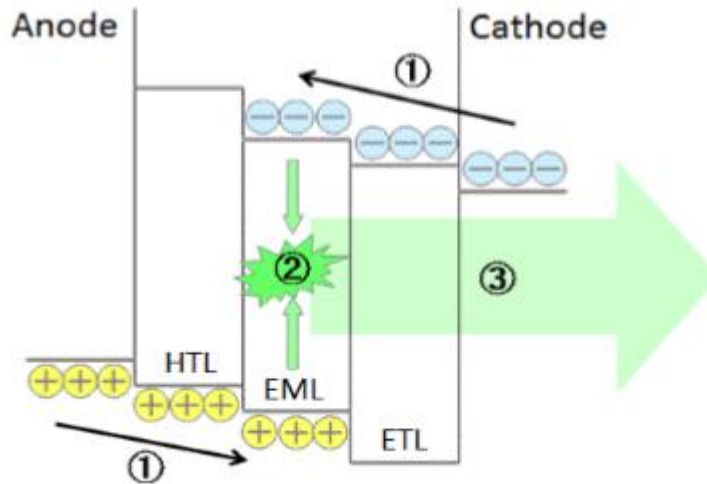

Figure 2: Scheme of the electroluminescence mechanism in an OLED.

- (1) electrons (blue) and holes (yellow) are injected from the electrodes to the organic emissive layer (EML).
- (2) formation of an electron-hole pair or exciton (green).
- (3) the radiative recombination of this exciton leads to a photon emission.

In 1987, Kodak scientists introduced a double layer organic light-emitting device (OLED), which combined modern thin film, thermal vacuum deposition technique with suitable small organic molecules to give moderately low bias voltages and attractive luminance efficiency. Although small molecules emitted bright light, scientists had to deposit them onto the substrates in a vacuum (an expensive manufacturing process called vacuum deposition). In 1990, researchers produced the first polymer light-emitting diode using a conjugated polymer, poly-para-phenylene vinylene (PPV), which is still one of the most often used polymers in OLEDs. A further boost for polymer-based devices came when emission was obtained from polyfluorenes. As of today, this kind of polymers exhibits the most promising characteristics for commercial applications. Devices based on this kind of polymer have now efficiencies in excess of 20 lm/W and are broadly comparable to inorganic LEDs based on

III-V semiconductors in terms of brightness and efficiencies. Polymers can be made less expensively and in large sheets, so they are more suitable for large-screen displays. Besides,

polymer OLEDs are quite efficient and require a relatively small amount of power for the amount of light produced.

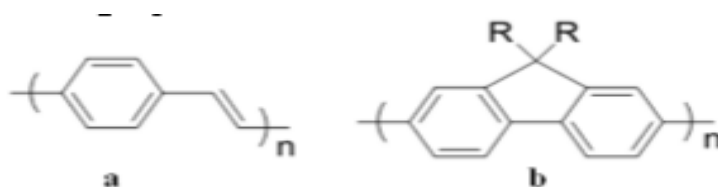

Figure 3: Mostly used polymers to produce electroluminescence in OLEDs.

High luminescence quantum yield from a single organic emitter, sandwiched between a transparent anode and a metallic cathode, is a very difficult one to meet by nearly all current materials. Thus, an efficient OLED with the single-layer configuration is very difficult to achieve and gives poor efficiency ($\sim 0.05\%$ for anthracene) and brightness or high driving voltage (larger than 100 V). The use of two layers of different organic materials substantially improved the external quantum efficiency ($\sim 1\%$) and decreased the driving voltage ($\sim 10\text{ V}$). Adding hole and electron blocking layers to force the charge carriers to recombine within the bulk have helped to achieve 8% efficiency for fluorescent OLEDs and 19% for phosphorescent OLEDs where the triplet excitons are also converted into light. Most highly fluorescent or phosphorescent organic materials of interest in OLEDs tend to have either n-type (electron transport) or p-type (hole-transport) charge transport characteristics. The color of the light depends on the type of organic molecule in the emissive layer. Manufacturers place several types of organic films on the same OLED to make color displays. The intensity or brightness of the light depends on the amount of electrical current applied: the more current, the brighter the light. The pursuit for efficient and long lasting OLEDs has seen significant effort in four fields of development: Materials, Device Structure, Optical Engineering and Electrical Engineering. In the next sections we will discuss the recent developments in these relevant fields for OLEDs.

2.MATERIALS

Materials are a critical factor for both efficiency and lifetime, the utilization of new materials has allowed revolutionary improvements in OLED efficiency. From the first generation fluorescent materials to the novel transport and emission layer host materials, the efficiency of OLEDs have grown more than tenfold and can now challenge and defeat LEDs in terms of efficiency at wavelengths close to 550 nm. Moreover, continued development of OLED materials have allowed for devices with hundreds of thousands of hours of operating lifetime. The components in an OLED differ according to the number of layers of the organic material. There is a basic single layer OLED, two layers and also three layers OLED's. As the number of layers increase the efficiency of the device also increases. The increase in layers also helps in injecting charges at the electrodes and thus helps in blocking a charge from being dumped after reaching the opposite electrode. Any type of OLED consists of the following components

2. 1. Substrate

The substrate is used to support the OLED. The substrate most commonly used may be a plastic, foil or even glass. OLED devices are classified as bottom emission devices if light emitted passes through the transparent substrate on which the panel was manufactured.

2. 2. Anode

The anode component usually used is indium tin oxide ITO. This material is transparent to visible light and is sufficiently conductor and has a high work function which promotes injection of holes into the HOMO level of the organic layer. A typical conductive layer behaving as a transparent electrode that replace the traditionally used ITO consist of PEDOT:PSS polymer or poly(3,4-ethylenedioxythiophene) poly(styrenesulfonate) as the HOMO level of this material generally lies between the work function of ITO and the HOMO of other commonly used polymers, reducing the energy barriers for hole injection. Another anode based on graphene yields to performance comparable to ITO transparent anodes.

2. 3. Cathode

The cathode component depends on the type of OLED required. Noteworthy, even a transparent cathode can be used. Usually metals like barium, calcium and aluminium are used as a cathode because they have lesser work functions than anodes which help in injecting electrons into the LUMO level of the different layers.

2. 4. Electrons transport layer

The commonly used components are: PBD, Alq3, TPBI and BCP10

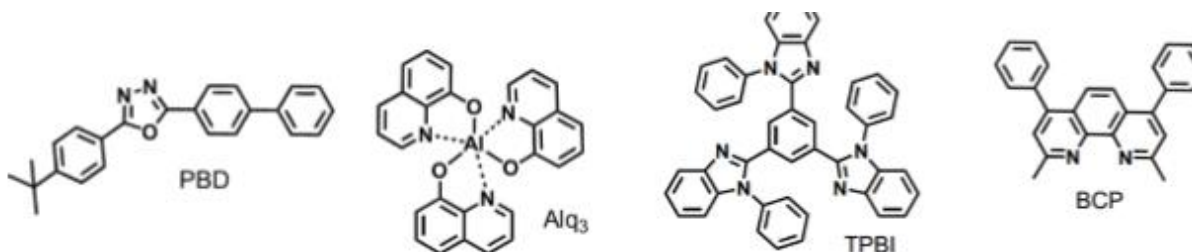

Figure 4 : Commonly used components in electrons transport layer

PBD = 2-(4-biphenyl)-5-(4-t-butylphenyl)-1,3,4-oxadiazole ; Alq3= tris(8-hydroxyquinoline) aluminum TPBI =1,3,5-tris(N-phenylbenzimidazol-2-yl)benzene ; BCP = bathocuprene

2. 5. Holes transport layer

The typically used p-type materials for HTL are TPD and NPB

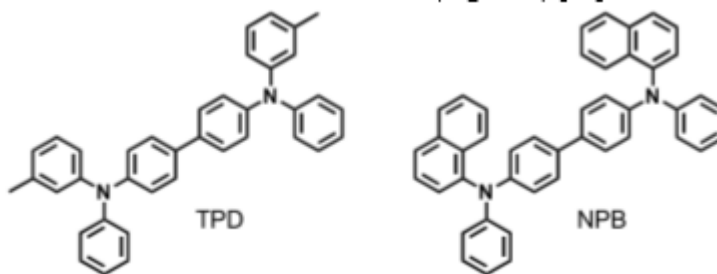

Figure 5 : Commonly used components in holes transport layer.

TPD=N,N-diphenyl-N,N-bis(3-methylphenyl)-1,1biphenyl-4,4-diamine;NPB=1,4-bis(1-naphthylphenylamino)biphenyl

2. 6. Emissive layer

The emissive layer component is made up of organic plastic molecules, out of which the most commonly used is polyfluorene. Such emitters are fluorescent dye and phosphorescent dye. In organic semiconductors holes are generally more mobile than electrons. The decay of the excited state results in a relaxation of the energy levels of the electron, accompanied by emission of radiation whose frequency is in the visible region. The frequency of this radiation depends on the band gap of the material, in this case the difference in energy between the HOMO and the LUMO. The color of the light produced can be varied according to the type of organic molecule used for its process. To obtain color displays, a number of organic layers are used. Another factor of the light produced is its intensity. If more current is applied to the OLED, the brighter the light appears

3. Device Structure improvements

The electrical engineering of OLED is in essence the design for efficient injection and transport of charge carriers and the design of the electron-hole balance in OLED devices.

3. 1. Tuning charges injection

In the single layer device described in Figure 6a, the organic emissive layer (EML) needs to be capable of maintaining high quantum efficiency as well as good hole and electron injection and mobility. Since most materials cannot meet this demand, multi-layer devices have been designed to improve charge injection and mobility. Indeed, charge injection and transport are the limiting factors in determining operating voltage and luminance efficiency. Generally, the efficiency of an OLED is determined by charge balance, radiative decay of excitons, and light extraction. In OLEDs, the hole current is limited by injection, and the electron current is strongly influenced by the presence of traps owing to metal–organic interactions. In order to enhance carrier injection the selection of efficiently electron-injecting cathode materials and the use of appropriate surface treatments of anodes are of great importance

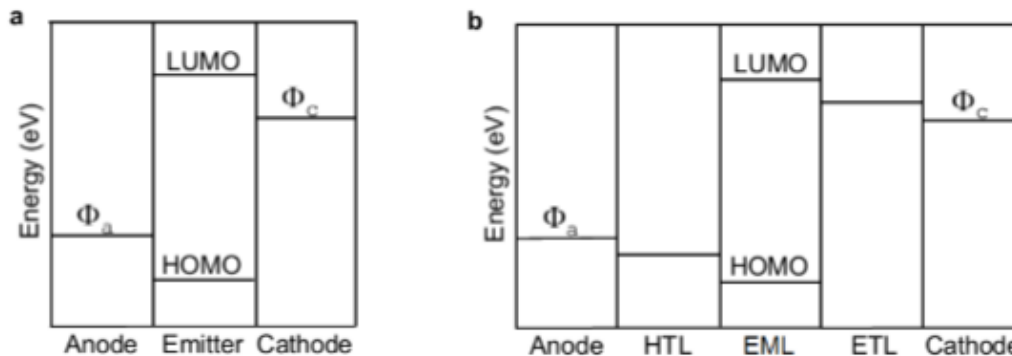

Figure 6: Energy-level diagrams of (a) a single-layer OLED and (b) a multilayer OLED with a hole transporting layer (HTL) and an electron transporting layer (ETL) sandwiching an emissive layer (EML).

Critical factors in constructing efficient electroluminescent devices are the barriers to hole and electron injection. If there is a large mismatch in energy between the HOMO and the anode work function (Φ_a) or the LUMO and the cathode work function (Φ_c), charge injection will be poor. Incorporation of a layer with either good hole or electron affinity between the emissive layer and the electrode reduces the energy barrier to charge injection. Substantial improvements in external quantum efficiencies and brightness were realized by fine tuning the charge injection barriers in OLEDs. This has been achieved using separate electrons transport materials (ETMs) and holes transport materials (HTMs) to improve and control charge injection and transport in OLEDs. The introduction of one or more layers of charge transport materials in addition to the emitter layer provides a powerful means to controlling charge injection, transport, and recombination in OLEDs. The presence of an ETM layer in the two-layer OLED configuration based on a p-type emitter not only lowers the barrier for electron injection but also serves to block holes since the ionization potential of ETMs are generally large. Since hole mobility is orders of magnitude larger than electron mobility in most emissive organic semiconductors the existence of an ETM layer can dramatically reduce the hole current in the OLED by virtue of the band offset and the greater electron mobility than hole mobility in the ETM. Similarly an HTM layer in combination with an n-type emitter, such as aluminum quinolate (Alq₃) or polyquinoline, can significantly improve OLED performance. In this case, the HTM facilitates hole injection and blocks electrons.

3. 2. Doping in transport layers

The principle tool for the electrical engineering of OLEDs is to chemically dope the transport layers. This allows for an increase in mobility within the transport layers, which in turn allows for reduced operating voltage and improved efficiency. The injection rates of both carriers (electrons and holes) should be almost equal for high efficiency. Otherwise, the surplus electrons or holes will not recombine, which results in low operation efficiency. We can overcome this disadvantage by employing multiple organic layers in the OLED structure. The emitter material can be either a layer between ETL and HTL or a dopant in one of these layers, close to the recombination zone. The dopant with a lower exciton energy than its matrix will yield a high luminescent efficiency. Organic molecular materials have low mobility (10^{-8} to 10^{-2} $\text{cm}^2/(\text{V s})$). Electron mobility in organic materials is generally orders of magnitude lower than hole mobility. As a consequence, low-voltage operation and high power efficiency are strongly controlled by the electron current from the cathode to the emissive zone. This argument has been further proved by the measurement of internal electric field in an OLED, in which the field in a NPB layer is considerably smaller than that in the Alq₃ layer at forward bias voltages.

3. 2. 1. Doping in ETLs

One of the promising solutions to reduce bias voltages in OLEDs is the use of n-type doping in ETLs [39]. Bright OLEDs have been achieved by using a Li-doped organic layer as an ETL with a molecular ratio of Li/Alq₃ at unity. In OLEDs with a configuration of ITO/NPB/Alq₃/Li-doped Alq₃/Al, the current density increases dramatically with increasing the thickness of the doped Alq₃ layer when the total thickness of the Alq₃ layer is constant. It is of importance to note that this approach not only increases the conductivity of the doped Alq₃ layer but also reduces the barrier to electron injection at the Alq₃/Al interface.

3. 2. 2. Doping in HTLs.

Doping was found to strikingly improve the properties of OLEDs. The use of p-type doping into hole transport materials has also been investigated, and the results showed that the doping considerably increased the bulk conductivity of the HTLs and led to a thinner space charge layer which could enable efficient tunnel injection of holes from the ITO to the doped HTL. A hole-transport material of vanadylphthalocyanine (VOPc) was doped with tetrafluoro-tetracyano-quinodimethane(F4-TCNQ) by co-sublimation. The conductivity increased by many orders of magnitude, and electrical measurements showed a smooth shift of the Fermi level towards the valence states with increasing doping.

3. 3. Phosphorescent OLED

Organic phosphors have demanded the attention of the organic electroluminescence community because they enable efficiencies quadruple that of fluorescent materials. Phosphorescent OLEDs generate light from both triplet and singlet excitons in a highly efficient manner, with the internal quantum efficiencies of such devices approaching 100%. An exciton formed by the recombination of electron and hole may either be in a singlet state or a triplet state, depending on how the spins have been combined. Typically, these excitons are localized on a small molecule, or localized to a region of a polymer chain, and hence it is often convenient to describe excitons as particles. Phosphorescence is distinguished from fluorescence by the speed of the electronic transition that generates luminescence. Both processes require the relaxation of an excited state to the ground state, but in phosphorescence the transition is quantum mechanically forbidden by selection rules meaning that the lifetime of triplet excitons is long. Hence, phosphorescence is slower than fluorescence, which arises from allowed transitions. Indeed, phosphorescence may persist for several seconds after a phosphorescent material is excited, whereas fluorescent lifetimes are typically on the order of nanoseconds. During electrical excitation approximately one singlet exciton is created for every three triplet excitons, but only relaxations of singlet excitons conserve spin and generate fluorescence because the ground state is typically also spin anti-symmetric. The excitons relax to a lower energy level by giving off light and/or heat. With conventional fluorescent emission, only about 25% of the excitonic energy generates light, when the remaining is lost as heat. Thus, if the energy contained in the triplet excitons cannot be directed to luminescence, the efficiency of an OLED is reduced by 75%. Fortunately, although the decay of a triplet state is disallowed by the

conservation of spin symmetry, it is occasionally observed if the triplet state is perturbed such that the transition becomes weakly allowed. In this case, the decay of the triplet state may still be very slow, but phosphorescence is generated. Efficient phosphorescence is rare at room temperature, and few materials luminesce efficiently in homogenous films due to the quenching of emission by surrounding molecules. The solution to these demands on OLED materials is found by doping the luminescent material into a charge transport host material. Emission then occurs in one of two ways: either by direct carrier trapping and exciton formation on the luminescent dye, or by exciton formation in the host and energy transfer to the luminescent guest. Hence, it is not sufficient merely for the guest to be phosphorescent from its triplet states; it must also be able to gather the triplets formed by electrical excitation. In fact, the addition of an extra hole blocking layer (HBL) or electron transport layer (ETL) with hole blocking properties enables the production of highly efficient phosphorescent OLEDs because triplet excitons are then confined in the light emitting layer (EML). The decay of a triplet state becomes weakly allowed by introducing heavier elements into a charge transport host material due to spin-orbit coupling and phosphorescence is generated. Typically, a polymer such as poly(nvinylcarbazole) is used as a host material to which an organometallic complex is added as a dopant. Iridium complexes behaves as (Red, Green and blue: RGB) emitters (e.g. Ir(mppy)₃ emits green light. Noteworthy, to use phosphorescent materials; their exciton energy must be lower than the host triplet (.e.g. a red phosphorescent emitter needs a blue host). Although complexes based on other heavy metals such as platinum have also been used.

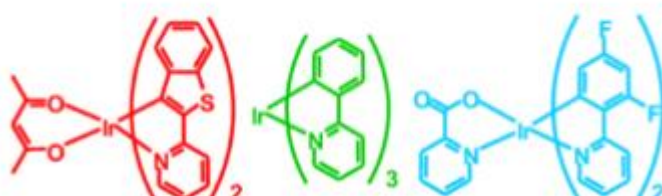

Figure 7: Example of Iridium-based phosphorescent dopants for RGB emitters

The heavy metal atom at the center of these complexes exhibits strong spin-orbit coupling, facilitating intersystem crossing between singlet and triplet states. By using these phosphorescent materials, both singlet and triplet excitons will be able to decay radiatively,

hence improving the internal quantum efficiency of the device compared to a standard polymer OLED where only the singlet states will contribute to emission of light. The use of macromolecular species like polyhedral oligomeric silsesquioxanes (POSS) in conjunction with the use of phosphorescent species such as Ir for printed OLEDs have exhibited brightnesses as high as 10,000 cd/m². The efficiency improvements offered by phosphorescence outweigh the slight increase in voltage that results from the use of large-energy-gap materials. Dendrimers are also an important class of light-emitting material for use in phosphorescent OLEDs. The different parts of the macromolecule can be selected to give the desired optoelectronic and processing properties. Highly efficient phosphorescent dendrimers have been reported to have external quantum efficiencies of up to 16%. The solubility of the dendrimers opens the way for simple processing and a new class of flat-panel displays.

4. Fabrication of OLEDs

Polymer-based OLEDs are attractive due to their excellent film forming properties and their ease of application over large surfaces through simple, economically viable coating techniques such as spin coating or ink-jet printing. Small molecule emissive materials are typically coated as thin films via vacuum-deposition which is difficult over large areas and is not as cost effective. The main part of manufacturing OLEDs is applying the organic layers to the substrate. This can be done in three ways:

4. 1. Vacuum deposition or vacuum thermal evaporation (VTE)

This is most commonly used for depositing small molecules. In a vacuum chamber (10⁻⁵ - 10⁻⁷ torr) the organic molecules are gently heated (evaporated) and allowed to condense as thin films onto cooled substrates. As the heating method is complicated and the strictness of parameters should be highly accurate, this method is more expensive and of limited use for large-area devices than other processing techniques. Vacuum deposition is not a suitable method for forming thin films of polymers. However, contrary to polymer-based devices, the vacuum deposition process enables the formation of well controlled, homogeneous films, and the construction of very complex multi-layer structures. This high flexibility in layer design,

enabling distinct charge transport and charge blocking layers to be formed, is the main reason for the high efficiencies of the small molecule OLEDs.

4. 2. Organic vapor phase deposition (OVPD)

This is an efficient technique which can be carried out at a low cost. In a low-pressure, hot-walled reactor chamber, a carrier gas transports evaporated organic molecules onto cooled substrates, where they condense into thin films. Using a carrier gas increases the efficiency and reduces the cost of making OLEDs.

4.3. Inkjet printing

This is the cheapest and most commonly used technique. Inkjet technology is highly efficient and greatly reduces the cost of OLED manufacturing and allows OLEDs to be printed onto very large films for large displays like big TV screens and electronic billboards. This method is same as the paper printing mechanism where the organic layers are sprayed onto the substrates.

4. 4. Transfer-printing

This is an emerging technology with the capability to assemble large numbers of parallel OLED and active matrix OLED (AMOLED) devices under efficient conditions. Transfer-printing takes advantage of standard metal deposition, photolithography, and etching to create alignment marks on device substrates, commonly glass. Thin polymer adhesive layers are applied to enhance resistance to particles and surface defects. The anode layer is applied to the device backplane to form bottom electrode. OLED layers are then applied to the anode layer using conventional vapor deposition processes, and covered with a conductive metal electrode layer. Transfer-printing is currently capable of printing onto target substrates up to 500mm x 400mm. Expansion on this size limit is needed in order for transfer-printing to become a common process for the fabrication of large OLED/AMOLED displays.

5. OLED's applications

OLEDs are used to create digital displays in devices such as television screens, computer monitors, portable systems such as mobile phones, digital media players, car radios, digital cameras, car lighting, handheld games consoles and PDAs. Such portable applications favor the high light output of OLEDs for readability in sunlight and their low power drain. Intense research has yielded OLEDs with remarkable color fidelity, device efficiencies and operational stability. According to the type of manufacture and the nature of their use, OLED's are mainly classified into several types:

5. 1. Passive-matrix OLED (PMOLED)

PMOLEDs have organic layers and strips of anode arranged perpendicular to the cathode strips. The intersections of the cathode and anode make up the pixels where light is emitted. The brightness of each pixel is proportional to the amount of applied current. External circuitry applies current to selected strips of anode and cathode, determining which pixels get turned on and which pixels remain off. PMOLEDs are easy and cheap to fabricate, but they consume more power than other types of OLED (mainly due to the power needed for the external circuitry) but still less power consuming than an LCD and LED. PMOLED displays are also restricted in resolution and size (the more lines you have, the more voltage you have to use). PMOLED displays are usually small (up to 3" typically) and are used to display character data or small icons: they are being used in MP3 players, mobile phone sub displays, etc.

5. 2. Active-matrix OLED (AMOLED)

AMOLEDs have full layers of cathode, organic molecules and anode. The anode layers have a thin film transistor (TFT) plane in parallel to it so as to form a matrix. This helps in switching each pixel to its on or off state as desired, thus forming an image. Hence, the pixels switch off whenever they are not required or there is a black image on the display, this helps in increasing the battery life of the device. This is the least power consuming type among others and also has quicker refresh rates which makes them suitable for video as well. The best uses for AMOLEDs are computer monitors, large-screen TVs (Figure 8a) and electronic signs or billboards.



Figure 8: a: Full-HD AMOLED TV (4mm thick and weighs just 3.5 Kg); b: Transparent OLED Laptop

5. 3. Transparent OLED

Transparent OLEDs (TOLEDs) have only transparent components: substrate, cathode and anode. When a TOLED display is turned on, it allows light to pass in both directions. This type of OLED can be included in both the active and passive matrix categories. As they have transparent parameters on both the sides, they can create displays that are top as well as bottom emitting. This device has a good contrast even in bright sunlight [53] so it is applicable in head-up displays, laptops (Figure 8b), mobile phones and smart windows.

5. 4. Top-emitting OLED

Top-emitting OLEDs have a substrate that is either opaque or reflective. Top-emitting OLEDs are better suited for active-matrix applications as they can be more easily integrated with a non-transparent transistor backplane. Manufacturers may use top-emitting OLED displays in smart cards.

5. 5. Foldable OLED

Foldable OLEDs (FOLEDs) have substrates made of very flexible metallic foils or plastics. FOLEDs are flexible, very lightweight and durable. This type is mainly used in devices which have more chance of breaking. As this material is strong it reduces breakage and therefore is used in GPS devices, cell phones (Figure 9a) and large curved screen TVs (Figure 9b). FOLEDs are offering crisper picture resolution, a faster response time and high contrast images for curved televisions, which manufacturers say offer a more immersive TV experience. Potentially, foldable OLED displays can be attached to fabrics to create "smart" clothing, such as outdoor survival clothing with an integrated computer chip, cell phone, GPS receiver and OLED display sewn into it



Figure 9: a: Foldable OLED Smartphone (Samsung galaxy S4); b: First curved OLED TV.

5. 6. White OLED

White OLEDs have the true-color qualities of incandescent lighting and emit white light that is brighter, more uniform and more energy efficient than that emitted by fluorescent lights and incandescent bulbs. Because white OLEDs can be manufactured in large sheets, are cost-effective and also consumes less power they can replace fluorescent lamps and could potentially reduce energy costs for lighting (Figure 10a). White OLED is perfectly suited for car lighting (Figure 10b) because it can display very deep black as well as light so that the displays can be crisp and easy to use while also showing a higher contrast than LCD and LED backlights. They are also very thin and lightweight which is something car makers are always looking for in order to make more compact, efficient vehicles. OLED uses less power for the

Dept. of ECE,KITE

same amount of light displayed than LCD and LED. Even using less power, OLED provides a brighter screen with more viewable angles. With luminous efficiencies that are up to four times higher than with fluorescent OLED materials, PHOLEDs also reduce heat generation. Because electrical energy that is not converted into light is converted into heat, displays and lights generally experience a temperature rise while operating. This elevated temperature becomes especially palpable in a large-sized OLED TV or lamp. With increased energy efficiency, PHOLED technology can dramatically reduce this increase in temperature and by the way reduce the demand for electricity and non-renewable fossil fuels. A low operating temperature is very important since it prolongs OLED lifetime as degradation increases with increasing temperature. It also reduces the amount of air conditioning required to remove the generated heat making PHOLED technology an important element in any “green” or environmental building strategy.

Due to their potentially high level of energy efficiency, even when compared to other OLEDs, PHOLEDs are being used in large-screen displays such as computer monitors or television screens, as well as general lighting needs. PHOLED panels are much more efficient and the colors are stunning. One potential use of PHOLEDs as lighting devices is to cover walls with large area PHOLED light panels. This would allow entire rooms to glow uniformly, rather than require the use of light bulbs which distribute light unequally throughout a room.



Figure 10: a: White OLED flat Lamps; b: White and other colors OLED used in car lighting.

Conclusion

A great deal of progress has been made in organic electroluminescent materials and devices in terms of synthesis, development, and application of electron transport materials as a means to improve OLED performance. The effectiveness of the OLED device is governed by three important processes: charge injection, charge transport and emission. Various layers in the organic stack are dedicated to one of the three processes above, such as surface modification in Hole Injection Layer and Electron Injection Layer, high mobility materials for transport with Hole Transport Layer and Electron Transport Layer, as well as Emission Layers with high efficiency emitter dopants. Intensive research activities in EL materials have yielded OLEDs with remarkable color fidelity, device efficiencies and operational stability. Charge injection and transport are critical in determining operating voltage and luminance efficiency. Higher electron mobility's are desirable in ETMs, particularly for OLEDs targeted for high brightness display and lighting applications. Various cathode materials and different surface treatments of ITO have been developed, leading to substantial enhancement of charge injection. For low-power consumption, it is highly desirable to design EL materials with superior electron mobility's. Doping is an effective approach to voltage reduction, but the formation of quenching centers in the emissive zone by rapid dopant diffusion is a prime concern. Luminance efficiency is mainly limited by non-radiative decay of excited states and internal optical loss of light. In order to achieve high device efficiency, the amount of electrons and holes arriving at the recombination and emission zone must be balanced. Engineering the mobility of the transport layers has a significant role in achieving electron-hole balance. The recombination in a fluorescent OLED is mainly non-radiative due to the selection law of spin conservation. Light emission through phosphorescent dyes has been utilized in OLEDs and gives good results. OLEDs have achieved long operational stability. The performance of OLEDs meets many of the targets necessary for applications in displays. Passive-matrix addressed displays are attractive, as the device construction is relatively simple. Advanced active-matrix displays have been demonstrated. The trend toward low power, lightweight and rugged displays led to the development of flexible OLEDs offering many advantages over both LCDs and LEDs. The substrate and organic layers of an OLED are thinner, lighter, more flexible and brighter than

the crystalline layers in an LED or LCD. Because OLEDs do not require backlighting, they consume much less power than LCDs. This is especially important for battery-operated devices such as cell phones. OLEDs are easier to produce and because they are essentially plastics, they can be made into large, thin sheets. OLEDs refresh faster than LCDs (almost 1,000 times faster) thus a device with an OLED display could change information almost in real time and hence video images could be much more realistic and constantly updated. Therefore, the newspaper of the future might be an OLED display that refreshes with breaking news. OLED seems to be the perfect technology for all types of displays but challenges are still ahead including high production costs, longevity issues for some colors (blue organics currently have much shorter lifetimes), sensitivity to water vapor (water can damage OLED displays easily and perfect sealing of the display is warranted, and it can also affect the longevity [55]). When displaying an image with a black background OLEDs are 34% power saving compared to polarization film; however OLEDs can use more power than LCDs to display an image with a white background such as a document or a website.

References

1. Karzazi Y., Cornil J., Bredas J. L., *J. Am. Chem. Soc.*, 123 (2001) 10076.
2. Karzazi Y., Cornil J., Bredas J. L., *Nanotechnology*, 14 (2003) 165.
3. Kulkarni A. P., Tonzola C. J., Babel A., Jenekhe S. A., *Chem. Mater.*, 16 (2004) 4556.