



Design of a PLC Based Biogas Stirring System in Anaerobic Bioreactor Feeding

Sefi Novendra Patrialova, Arief Abdurrahman,
Vania Neola Belva and Maulina Kartika

EasyChair preprints are intended for rapid dissemination of research results and are integrated with the rest of EasyChair.

November 21, 2022

Design of a PLC Based Biogas Stirring System in Anaerobic Bioreactor Feeding

*Sefi Novendra Patrialova¹, Arief Abdurrakhman², Vania Neola Belva³, Maulina Kartika⁴

¹Department of Instrumentation Engineering, Sepuluh Nopember Institute of Technology, Surabaya, Indonesia

* Correspondence: maulinakartika23@gmail.com

Abstract— Stirring in Feeding Biogas needs to be done because it affects the quality of biogas results. The controller used is a PLC, a 3 Phase AC motor is used to drive the agitator, the sensor used namely the Optocoupler-based Rotary Speed Sensor, and the MQ 4 Sensor is used to measure the levels of methane gas. The data taken from the sensor will be stored in cloud storage so that the GUI can monitor it. The results of the FC-03 optocoupler sensor readings are good with an overall average accuracy of 99.32% with an error percentage value of 0.64%. As for the results of reading the methane gas sensor, it is 97.99% with an error percentage value of 2.1%. The best time to determine the level of methane gas is at 12.

Keywords — *Stirring system, Feeding Bioreactor*

I. INTRODUCTION

Pakal City Forest has a farm where the current total is 8 cows and 18 goats. Pakal City Forest Manure has been used for use as biogas. All the dirt is collected in the shelter which is usually called a feeding bioreactor which is then mixed with water. After process mixing, the impurities will automatically enter the biodigester reactor with fixed dome with a volume of 11 m³ for the fermentation process. After 7 days, the biogas will appear and is channelled through catch pipes which are then used by the community around both farmers and residents for cooking and lighting in the cage [1], [2]. The current condition of the biogas installation in the Pakal City Forest is in a cow dung reservoir (feeding) anaerobic bioreactor) does not have a

stirring system used for mixing cow dung and water, as a result, solid deposits occur and accumulate in the tank from the shelter. These problems show that the mixing system is very important for avoid the formation of foam in the digester [3]. Mixing biogas that we often encounter is manual mixing, Mixing is done with the help of human power [4]. In fact, mixing biogas using technology like PLC can shift the biogas production time to one to two days earlier [5], [6]. Previous study had been carried out by Soehartanto in 2013 with the title System Design Mixer in Batch Bioreactor to Increase Biogas Production. Study design and manufacture batch bioreactors with single blade stirrer which can homogenize the substrate from tofu and water hyacinth wastewater when precipitation occurs which affect biogas production [7]. Yet, on other research in 2022, mixing is done by stirring the ingredients fermentation with a controlled and systematically observed speed will be obtained optimal biogas production results [8].

This research plant has advantages such as mixing controlled automatically by PLC and assisted by a 3-phase AC motor to move [9], control data storage is stored in spreadsheet database so that operations can be used easily and become a solution in biogas development [2].

II. METHODOLOGY

A. *Hardware Design and Manufacturing*

The design of the Stirring System is carried out on an anaerobic feeding bioreactor which aims to maximize the biogas

formation process so that no precipitation occurs feed the biogas reactor[10], [11]. In Figure 1 is the Wiring Diagram of the Stirring System, that will be implemented using PLC [12].

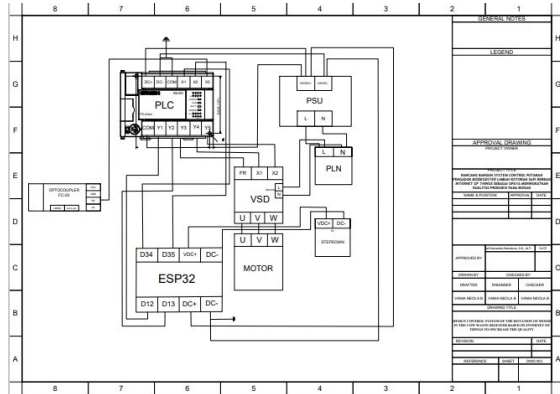

Figure 1 Wiring Diagram of Biogas Mixing System

Figure 1 is the Wiring Diagram of the Stirring System, where when the push button is ON it will send a PLC signal, and the PLC will activate the output command found on pin Y1 on the PLC to run VSD. In addition to sending commands to Y1, it will also send analog output commands to the PLC on Channel 1. Analog output is used as a reference for motor rotation speed.

When the VSD gets the running command, then VSD is already in the running position and the frequency will be 0 after the analog comes out [13], [14], it will be the VSD speed reference (the frequency is based on the analog value of the reference). If the button is pressed, the running position if it starts it will switch to the next stage, where stage to send the run output function to the inverter and send a different frequency or analog value. Voltage of different analog value will be read in VSD if different Frequency will increase according to analog value[15].

In this research, a stirring system that can stir with a capacity of 20kg is used. Mixing Biogas is designed with a paddle stirring type model that adjusts the object, namely cow dung and water [16]. Mixing using iron. With a height of 30 cm and a

width of 40 cm. And the work of the system can be known through Figure 3.

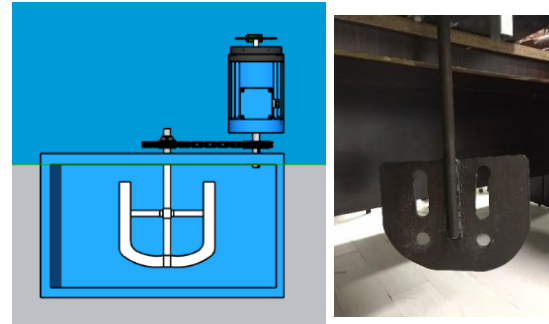

Figure 2 Stirring Type Paddle



Figure 3 Block diagram of the Biogas Control System (Author's Personal Document)

Based on the block diagram, the stirring control system is an open loop. The sensor used is the optocoupler sensor which will be installed on the pulley of the stirring blade driving motor [9]. The input set point will be sent to the controller to condition or send commands to the actuator to run the system according to the desired set point. PLC is used for the stirrer rotation controller system [10], [17].

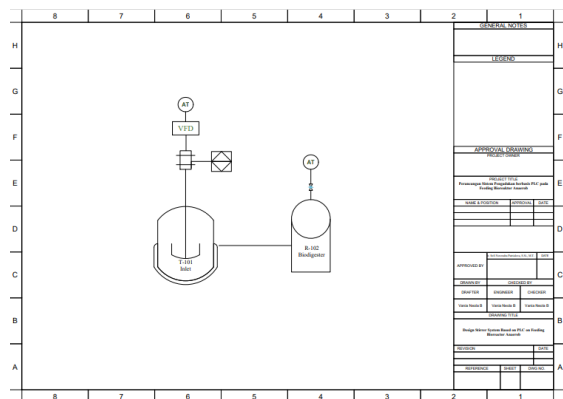

Figure 4 P&ID Biogas stirring system (Author's Personal Document)

The wiring of the hardware is shown on figure 5 below. The control panel consist of HMI, PLC, Push Button, microcontroller, and other components that need for the system.

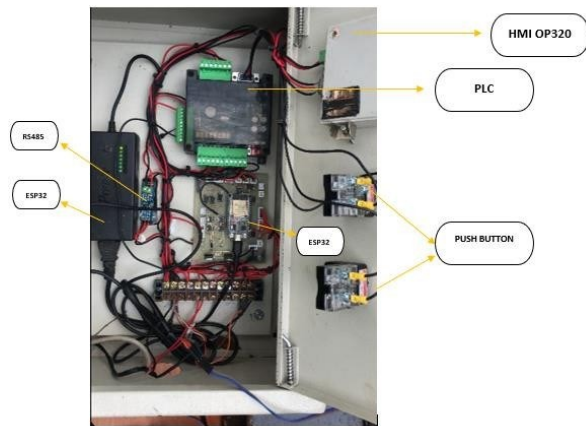

Figure 5 Wiring of the Biogas Stirring System on the Panel Box

When all the wiring on the hardware is installed, the next step is to integrate analog output from the PLC which aims to check whether the analog output can work properly or not.

In this research, an optocoupler type fc-03 based speed sensor is used.

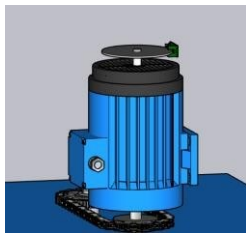

Figure 6 Optocoupler based Speed Sensor Deployment (Author's Personal Document)

The picture above is an optocoupler-based speed sensor mounted on the pulley of the stirring blade motor drive. The optocoupler sensor is used to measure the speed at which the stirrer rotates. The Specifications of the Optocoupler-based Speed Sensor are as follows.

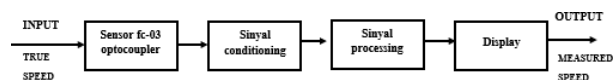

Figure 7 The measurement block diagram of the optocoupler-based speed sensor

In the block diagram the measurement consists of input, namely the real speed value, then sensed by a speed sensor based on an optocoupler with an output voltage of 1.7v and then signal conditioning by an

amplifier with an output voltage of 3.3 v to 24v and then controlled by PLC and then display is HMI Signal conditioning by an amplifier with an output voltage of 3.3 v to 24v then controlled by the PLC and then the display is HMI.

B. Software Design and Manufacturing

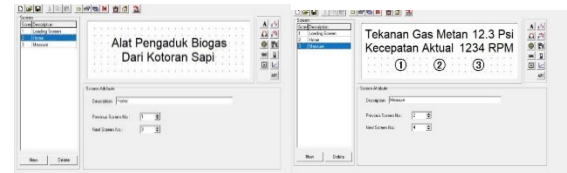

Figure 8 User Interface Design on HMI

The picture above is a design on the Human Machine Interface (HMI) for biogas mixing which can display the results of speed measurement data (rpm) and CH₄ methane gas (PPM).



Figure 9 UI display results on HMI OP320

Programming in visual studio 2019 was carried out to create a Graphical User Interface (GUI) used as a visualization of the data measured by sensors and as a display of the results of monitoring the energy management system. The GUI design is done using the visual studio 2019 application with the visual basic language.

Data acquisition is the process of taking data from sensors that are converted into electrical signals and converted to digital numbers that will be processed and analysed through a computer. The data

acquisition section starts from the signal processing unit, sensors, hardware, and computer unit. The working system of sending measurement data to the database is from the Optocoupler Sensor read ESP32, the data read will be sent on the web hub or related web. The web is developed by a protocol commonly known as IFTTT. IFTTT is a source code or open-source platform that has been widely used by people to connect IoT hardware with clouds/spreadsheets etc. The way IFTTT works here is as network gateways as a communication bridge between ESP32 and spreadsheets, in IFTTT it will connect programs in ESP32 with spreadsheets.

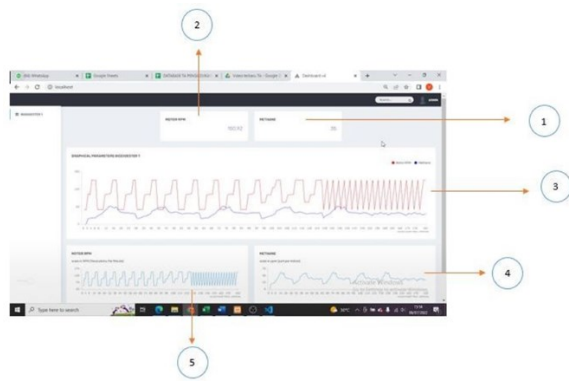

Figure 10 Graphical User Interface Display (Author's Personal Document)

C. Components Testing and Mechanism

After the system is completed integration, the system is used for testing carried out by testing sensors, namely validation. The validation process starts from the preparation stage then places sensors and measuring instruments on the test site. The readings from sensors and measuring instruments are then evaluated and then proceed to take the right steps as instrument technicians by adjusting the hardware and software. The first validation is carried out on the optocoupler sensor FC-03. The validation of the Optocoupler FC-03 sensor is done by comparing the reading data from the sensor and Tachometer. After that the Validation Mechanism on CH₄ (MQ4) methane gas sensor is carried out. The MQ4

Sensor validation is done by comparing the reading data from the sensor and the Gas Detector Mestek cgd02. The optocoupler sensor is placed on the biogas output which is in the biogas connecting pipe with the biogas output. The measurement result of the value of methane gas using the MQ4 sensor will be displayed on the HMI and the application on bylnk. Processing the data that we get from the test results to get and find out the feasibility level of the sensor.

Lastly is the actuator testing mechanism. The actuator testing for biogas mixing uses the speed of the stirrer rotation which is measured using the Optocoupler FC-03 sensor and a tachometer. In testing this actuator using setpoint 3 speed variations, namely slow, medium, and fast. Speed 1 is speed variation 1 with a setpoint of 50rpm, Speed 2 is speed variation 2 with a setpoint of 100rpm and speed 3 is speed variation 3 with a setpoint of 150rpm. This test aims to determine whether the control system is working well or not.

III. RESULTS AND DISCUSSION

A. System Design Result



Figure 11 System Design Result

Figure 11 shows how the system integration is adjusted the design that has previously been made with the input and output. The actuator that has connected to the PLC inside the panel box put on the top of the biodigester. The communication serial and microcontroller also put inside the panel

box; all the pushbuttons connected to the controller.

Electronics components are arranged inside the panel box so that they are not visible from the outside and must be opened first. This system has the main function as a in speed and methane sensor testing because it can perform setpoint manipulations that can be used for testing. The system detects speed and methane gas and will perform readings and displays on the display. The detected gas is then recorded for validation test from the sensor.

B. System Testing

The first test was the data taken for validation of the Optocoupler FC-03 sensor using tachometer. This validation process is used to determine the accuracy value of the FC-03 sensor by using 3 speed variations ranging from 75 RPM to 200 RPM. After the validation process, it showed that the average accuracy value obtained on the FC-03 sensor was 99,32%.

Then the methane gas sensor validation is being conducted to know the accuracy of the sensor. MQ4 Sensor Testing with Gas Detector Mestek cgd02. The test is carried out after the stirring process and data collection of speed sensor validation (Optocoupler sensor). The anaerobic fermentation process for biogas formation occurs for 2 weeks. Data were collected 3 times in one day (Morning, midday, and afternoon). it showed that the average accuracy value obtained on the FC-03 sensor was 99,32%.

The next step is the actuator test to read the rpm of the motor rotation at each motor setting speed, the test is carried out by activating stirring with the start button and recording the time how long it takes the system to reach (finish) with speed 1, speed 2, and speed 3. The result of the dynamic response is depicted from the figure below

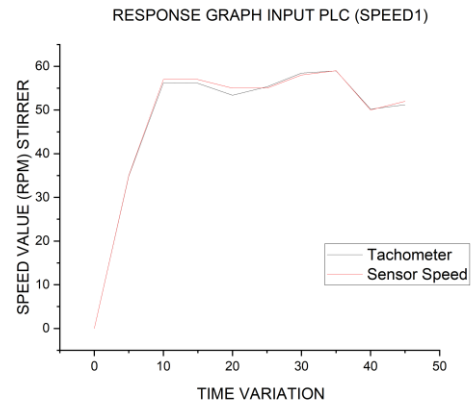

Figure 12 Response Graph Receiving PLC at Speed 1

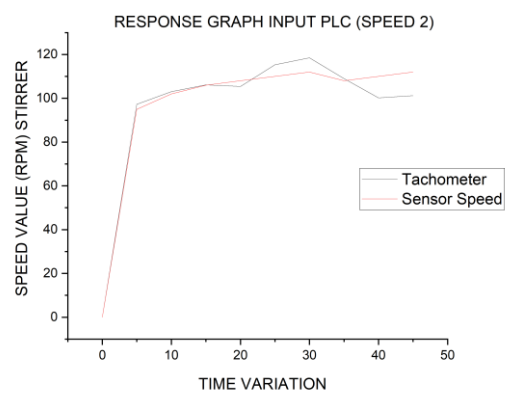

Figure 13 Response Graph Receiving PLC at Speed 2

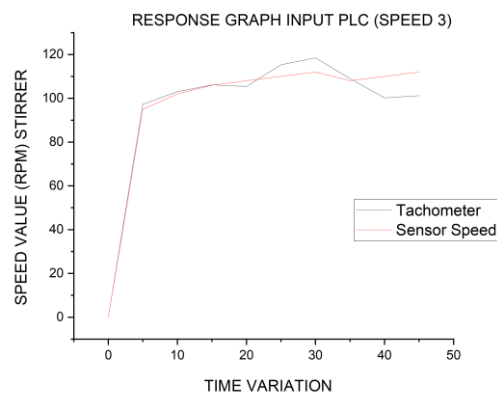

Figure 14 Response Graph Receiving PLC at Speed 3

In figure can be seen change in the speed of the stirrer rotation from the control system test at variation of speed 1, 2, and 3 (fast speed). The initial state of the speed which originally had a value according to the real state was controlled to a speed level that matched the expected setpoint.

The next is the data collection of methane (CH₄) gas content in two conditions, namely the retrieval is carried out when the position has not been stirred and the position has been stirred. Data collection was carried out for 3 days considering the time, weather and the surrounding environment. Data collection was carried out in the morning, afternoon and evening. In the morning it is done at 06.30, in the afternoon it is done at 12.00 and in the afternoon, it is done at 16.00.

Table 1 Methane Gas Level Measurement Before Stirring

NO	TIME	METHANE CH ₄ (PPM)	
		VALIDATOR	MQ4
1	06.05	8	8
2	12.00	14	16
3	16.00	12	12
4	06.15	14	13
5	12.00	24	22
6	16.00	18	18
7	06.30	20	20
8	12.00	25	24
9	16.00	21	21
Σ		156	154
Avg		17,33	17,11

The table above shows the results of calculating the content of methane gas in the biogas digester before undergoing the stirring procedure. as has been done in the experiment, the sensor is able to produce an accurate calculation, which is equal to 99,32%, indicating the accuracy of the sensor. the greater the value of accuracy, the more precise the sensor readings. After the stirring procedure was carried out at three different speeds, the results of the readings of the methane gas content in the tank are shown in the following table:

Table 2 Methane Gas Level Measurement After Stirring

NO	TIME	METHANE CH ₄ (PPM)	
		VALIDATOR	MQ4
1	06.05	8	8
2	12.00	14	16
3	16.00	12	12

4	06.15	14	13
5	12.00	24	22
6	16.00	18	18
7	06.30	20	20
8	12.00	25	24
9	16.00	21	21
Σ		156	154
Avg		17,33	17,11

In table 2 above, measurements have been made to determine the levels of methane gas after stirring. The result also shown in figure.. Measurements were taken from June 18 to June 20 by taking 3 times, namely morning at 06.00, afternoon at 12.00 and afternoon at 16.00. At the time of data collection, the weather was in normal condition with a temperature of 32°C. From the table, a methane gas content is generated with an average of 31.00 for the validator value and 29.78 for the sensor value. From these measurements, the results of the best methane gas levels occur at noon at 12.00, because during the day, the pressure is higher than in the morning or evening, which have been stirred for 3 consecutive days with different speed variations.

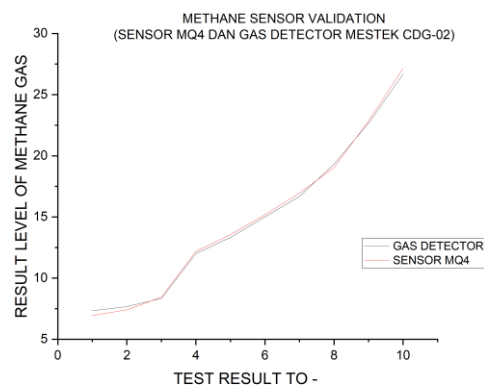

Figure 15 MQ4 Sensor Validation Methane Gas Measurement

IV. CONCLUSION/SUMMARY

The data taken from the sensor will be stored in cloud storage so that it can be

monitored by the GUI. The result of measuring the rotation speed of the stirrer by the optocoupler sensor has a different value from the standard reading, this is due to a delay when the stirrer starts to run. However, the results of the FC-03 optocoupler sensor readings are good with an overall average accuracy of 99.32% with an error value of 0.68%. As for the readings of the methane gas sensor, which is 97.99% with an error value of 2.01%. From the results of the measurement of methane gas content it can be concluded that the stirring process in biogas is very influential, by looking at the measurement results when taking measurements before the conditions are mixed, the methane gas content produced by the results has an average value of 17.22ppm different from the position already stirred has an average value of methane gas content of 30.39 ppm by considering the time of data collection. The best time to determine methane gas levels is at 12.00, from the results of measurements made under these conditions, the value of methane gas levels has increased this is due to higher pressure during the day than in the morning and evening.

REFERENCES

- [1] M. Mulyati, "Analisa Teknoekonomi Biogas Dari Eceng Gondok dengan Stater Kotoran Sapi," *J. Energi dan Teknol. Manufaktur*, vol. 1, no. 02, pp. 39–44, 2018, doi: 10.33795/jetm.v1i02.15.
- [2] U. S. Dharma, J. Teknik, M. Fakultas, and U. M. Metro, "Kajian Potensi Sumber Energi Biogas Dari," *Turbo*, vol. 3, pp. 34–41.
- [3] R. K. Sahu, R. Shankar, P. Mondal, and S. Chand, "Treatment potential of EC towards bio-digester effluent: effects of process parameters, aeration, and adsorbent," *Desalin. Water Treat.*, vol. 54, no. 7, pp. 1912–1924, 2015, doi: 10.1080/19443994.2014.895776.
- [4] P. Anggakara and I. W. Wardhana, "Pengaruh Pengenceran dan Pengadukan Terhadap Produksi Biogas Pada Limbah Industri Kecil Pengasapan Ikan Dengan Menggunakan Ekstrak Rumen Sapi Sebagai Starter," *Tek. Lingkung.*, vol. 1, no. 1, pp. 1–8, 2013.
- [5] R. Indrawati, "Penurunan Bod Pada Biogas Kotoran Sapi Campuran Limbah Cair Industri Penyamakan Kulit Dengan Variasi Kecepatan Dan Lama Pengadukan," *J. Res. Technol.*, vol. 3, no. 2, pp. 44–53, 2017, [Online]. Available: <https://journal.unusida.ac.id/index.php/jrt/article/view/239/191>
- [6] M. A. Muslim and G. Gumilar, "Rancang Bangun Sistem Kontrol Kekentalan dan Temperatur pada Digester Anaerob," pp. 132–137, 2018.
- [7] C. W. Y. dan T. Soehartanto, "Pak Totok," *J. Tek. POMITS, No. 1, ISSN 2337-3539 (2301-9271 Print)*, vol. Vol. 2, no. 1, 2013.
- [8] I. L. Quintanilla-Mosquera *et al.*, "Design of an automated manure collection system for the production of biogas through biodigesters," *2022 IEEE Int. IOT, Electron. Mechatronics Conf. IEMTRONICS 2022*, 2022, doi: 10.1109/IEMTRONICS55184.2022.9795763.
- [9] B. S. Utomo and M. Faridha, "Efisiensi Energi Listrik Menggunakan Variable Speed Drive (VSD) Pada Motor Induksi 3 Phasa".
- [10] C. Xu, Y. Zhou, S. Cai, R. Qin, Y. Liang, and B. Pang, "Designing and research of a Solenoid valve Operating Life test system," *Proc. 2012 2nd Int. Conf. Instrum. Meas. Comput. Commun. Control. IMCCC 2012*, pp. 53–56, 2012, doi: 10.1109/IMCCC.2012.19.

- [11] R. Fitriadi, A. Al Ghofari, and G. Kuncoro, "Modul Sistem Kontrol Industri Menggunakan PLC," *Semin. Nas. IENACO*, pp. 272–280, 2014, [Online]. Available: <http://publikasiilmiah.ums.ac.id:8080/handle/123456789/4557>
- [12] A. Nsair, S. Önen Cinar, H. Abu Qdais, and K. Kuchta, "Optimizing the performance of a large scale biogas plant by controlling stirring process: A case study," *Energy Convers. Manag.*, vol. 198, no. August, p. 111931, 2019, doi: 10.1016/j.enconman.2019.111931.
- [13] F. Kaswinarni, "Studi Kasus Industri Tahu Tandang Semarang , Sederhana Kendal dan," *Kesehat. Lingkunang*, vol. 4, no. 2, pp. 1–20, 2012.
- [14] A. M. Ritonga and M. Masrukhi, "Optimasi Kandungan Metana (CH₄) Biogas Kotoran Sapi Menggunakan Berbagai Jenis Adsorben," *Rona Tek. Pertan.*, vol. 10, no. 2, pp. 11–22, 2017, doi: 10.17969/rtp.v10i2.8493.
- [15] R. Mustami, S. Ainun, and E. Hartati, "Karakteristik Substrat dalam Proses Anaerob Menggunakan Biodigester," *Reka Lingkungan.*, vol. 3, no. 2, pp. 1–12, 2015.
- [16] A. M. Abubakar, "Biodigester and Feedstock Type: Characteristic, Selection, and Global Biogas Production," *J. Eng. Res. Sci.*, vol. 1, no. 3, pp. 170–187, 2022, doi: 10.55708/js0103018.
- [17] D. Dong and X. Li, "Development of a novel parallel-spool pilot operated high-pressure solenoid valve with high flow rate and high speed," *Chinese J. Mech. Eng. (English Ed.)*, vol. 28, no. 2, pp. 369–378, 2015, doi: 10.3901/CJME.2015.0104.001.